

BS-2053, 2054 Biological Microscope



BS-2053B



BS-2053T



BS-2054B



BS-2054T

Introduction

BS-2053 and BS-2054 series microscopes are specially designed for various microscopy needs such as teaching and clinical diagnosis. It has good optical quality, wide field of view, excellent objective performance, clear and reliable imaging. Ergonomic design provides better comfort and use experience, pays attention to the user's operating habits, starts from the details, and constantly optimizes. Modular design can realize various observation methods such as bright field, dark field, phase contrast, fluorescence, etc., providing more possibilities for your scientific research and exploration. It takes up little space and is very convenient for handling, storage and maintenance, it is the first choice for microscope beginners.

Feature

1. Excellent Image Quality

NIS optical system and optical elements using advanced coating technology make it easy to obtain good quality imaging. Excellent optical system is the guarantee of obtaining plan and clear images. Infinite achromatic semi-pan

objective and even plan objective can be used in this microscope. It can provide clear images with high contrast, and the clear range can reach to the edge of the field of view. It also has bright and uniform illumination.

2. BS-2054 has color temperature adjustable function

BS-2054 has color temperature adjustable function, the color temperature can be adjusted to makes the sample present natural color. Its color temperature changes according to observation needs, even if the user changes the brightness, it can maintain the brightness and color temperature comfortably. The LED design life is 60,000 hours, which not only reduces maintenance costs, but also stabilizes the brightness during the whole service life.

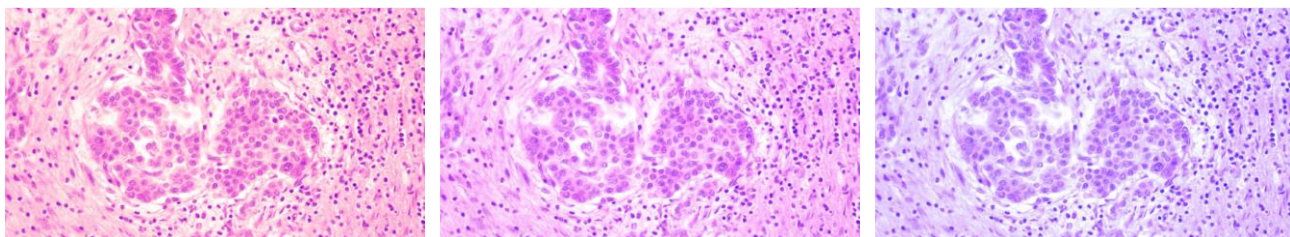

3. Wide Field of View

BS-2053, 2054 series microscopes can achieve the 20mm wide field of view under the 10X eyepiece, with more comprehensive observation field and faster sample observation. The eyepiece adopts the plan and distortion-free design to prevent blurring at the edges of the field of view and stray light.

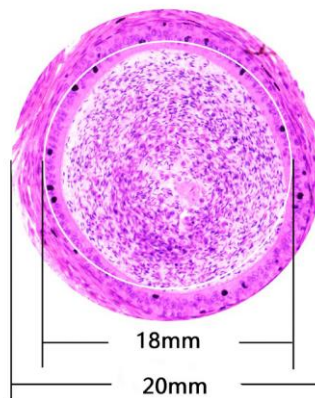

4. Realize Various Observation Methods

Bright Field	Dark Field	Phase Contrast	Fluorescence	Simple Polarization
●	●	●	●	●

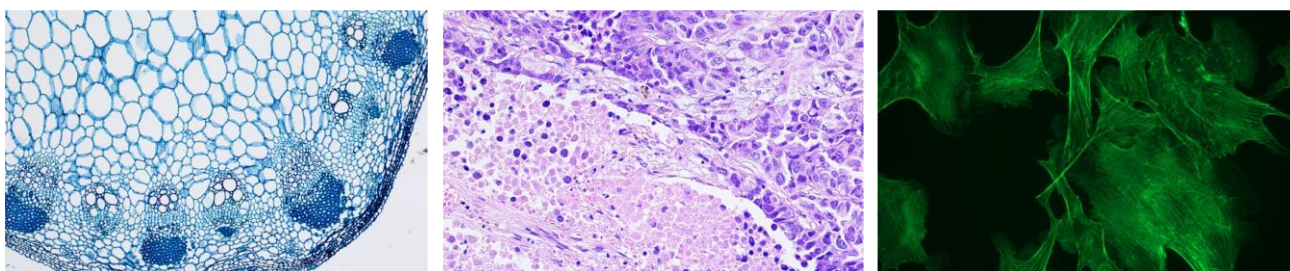

5. Applicable to Any Environment

Anti-mold treatment greatly extends the service life of the microscope. Since the objective, eyepiece and observation tube are all effectively anti-mildew treated, they can ensure continuous clear image and prolong the service life of the microscope. Even working in hot and high humid environment is not affected the working life.

6. Easy to Store and Transport

BS-2053, BS2054 series microscopes are small enough to fit into a common classroom cabinet. There is a special carrying handle at the back, and it has light weight, good stability and stable structure. The back panel of the microscope is designed with a hub device, which can effectively store the long power cord, improve the cleanliness of the laboratory, and also reduce the trip accidents caused by the long power cord during transportation. Wooden storage box as an optional accessory can bring great convenience for storage and handling.



7. External power adapter, safer than ordinary microscopes.

External power adapter with DC5V input, safer than ordinary microscopes.

8. Ergonomic Design

BS-2053, BS2054 series microscopes adopt ergonomic design, high eye point, low-hand focusing mechanism, low-hand stage and other ergonomic designs to ensure that users can operate the microscope under the most comfortable conditions and minimize the working fatigue.



9. Extremely Smooth Nosepiece

The nosepiece adopts a low damping design, high-precision machining ensures smoothness and durability in use. The nosepiece has a rubber ring, which is ergonomic and easy to convert.

10. Stage Designed for Beginners

The rackless stage prevents users from being scratched by exposed rack during use. The slide clip can be easily operated with one hand. When the upper limit of the stage is locked, accidental contact between the objectives and the slide can be avoided, which can prevent damage to samples and objectives. The coarse focus torque adjustment device can adjust the comfort of use according to personal operating habits.



11. Binocular head with built-in WIFI digital camera is optional

Built-in high-definition HDMI&WIFI digital camera, support 5.0MP picture capture, 1080P video preview and capture. Supporting Android, IOS, windows operating system. The high-definition images under the microscope can be output to external devices in real time, and there is no data cable connection, the operator is more free to move. Observation, analysis and processing of microscopic imaging can be realized in external equipment, including photographing, measurement, image adjustment, storage, processing, etc.



12. Coded Nosepiece

BS-2054 has coded nosepiece, the illumination brightness could be remembered. When different objectives are switched, the light intensity is automatically adjusted to reduce visual fatigue and improve work efficiency.

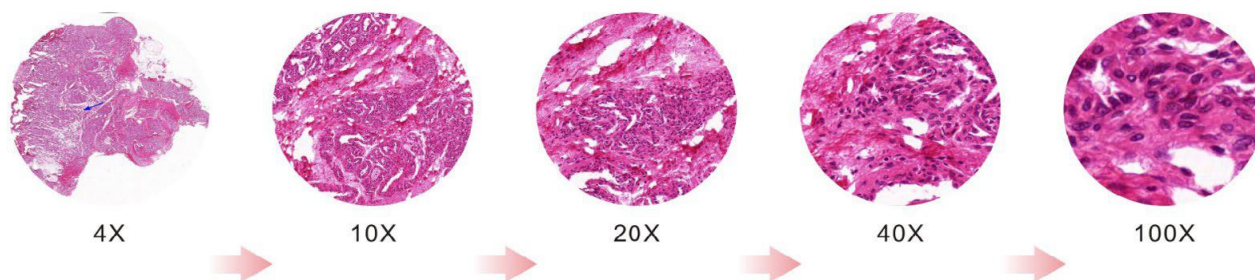

13. Microscope Use Status Display

The LCD screen in the front of the BS-2054 series microscopes can display the working status of the microscope, including magnification, light intensity, standby status, etc.

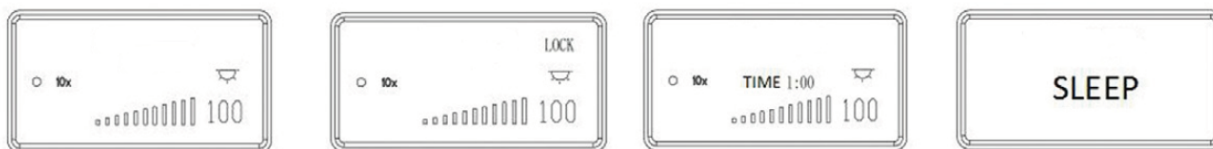

Start&working mode

Lock mode

ECO mode

Sleep mode

Application

BS-2053, 2054 series microscopes are ideal instruments in biological, pathological, histological, bacterial, immune, pharmacological and genetic fields. They can be widely used in medical and sanitary establishments, such as hospitals, clinics, laboratories, medical academies, colleges, universities and related research centers.

Specification

Item	Specification	BS-2053B	BS-2054B	
Optical System	Infinite Optical System	●	●	
Eyepiece	WF10×/20mm	●	●	
Viewing Head	Seidentopf Binocular Head, inclined at 30°, Interpupillary 47-78mm, both eyepiece tube diopter adjustable	●	●	
	Seidentopf Trinocular Head, inclined at 30°, Interpupillary 47-78mm, both eyepiece tube diopter adjustable	○	○	
	Seidentopf Binocular Head with built-in USB2.0 digital camera (8.3MP/5.1MP, 30fps), inclined at 30°, Interpupillary 47-78mm, both eyepiece tube diopter adjustable	○	○	
	Seidentopf Binocular Head with built-in HDMI&WIFI digital camera (5.0MP image capture, 1080P video preview and capture, 30fps), inclined at 30°, Interpupillary 47-78mm, both eyepiece tube diopter adjustable	○	○	
Objective	Infinite Semi-Plan Achromatic Objectives	4×, NA=0.10, WD=28mm	●	●
		10×, NA=0.25, WD=5.8mm	●	●
		40× (S), NA=0.65, WD=0.43mm	●	●
		100× (S, Oil), NA=1.25, WD=0.13mm	●	●
	Infinite Plan Achromatic Objectives	2×, NA=0.05, WD=18.3mm	○	○
		4×, NA=0.10, WD=28mm	○	○
		10×, NA=0.25, WD=10mm	○	○
		20×, NA=0.40, WD=5.1mm	○	○
		40× (S), NA=0.65, WD=0.7mm	○	○
		50× (S, Oil), NA=0.90, WD=0.12mm	○	○
		60× (S), NA=0.80, WD=0.14mm	○	○
	Infinite Plan Fluorescent Objective	100× (S, Oil), NA=1.25, WD=0.18mm	○	○
		4×, NA=0.13, WD=16.3mm	○	○
		10×, NA=0.30, WD=12.4mm	○	○
		20×, NA=0.50, WD=1.5mm	○	○
		40× (S), NA=0.75, WD=0.35mm	○	○
100× (S, Oil), NA=1.30, WD=0.13mm		○	○	
Nosepiece		Backward Quintuple Nosepiece	●	
		Backward Coded Quintuple Nosepiece		●
Stage	Rackless Double Layers Mechanical Stage 150mm×139mm, Moving Range 75mm×52mm	●	●	
Condenser	Abbe Condenser NA1.25	●	●	
	Dark Field Condenser (Dry / Oil)	○	○	
Focusing	Coaxial Coarse and Fine Adjustment, Left hand has Height Limit Lock, Right Hand has Coarse Tension Adjustment Function. Coarse Stroke 37.7mm per Rotation, Fine division 0.002mm, Fine Stroke 0.2mm per Rotation, Moving Range 20mm	●	●	
Illumination	3W LED Illumination, Brightness Adjustable	●	●	
	Kohler Illumination	○	○	

	Illumination management system, LCD Displays Magnification, Brightness, Color Temperature adjustment, etc	○	●
Other Accessories	Dust Cover	●	●
	Power Adapter DC5V Input	●	●
	Instruction Manual	●	●
	Green Filter	●	●
	Blue/Yellow/Red Filter	○	○
	0.5× C-mount Adapter	○	○
	1× C-mount Adapter	○	○
	BPHB-4 Phase Contrast Kit	○	○
	Simple Polarizing Set	○	○
	FL-LED Epi-fluorescent Attachment	○	○
Mercury Fluorescent Illumination	○	○	
Reliability	Anti-mold Treatment on all the optics	●	●
Packing	1pc/carton, 36*26*46cm, gross weight: 8kg	●	●

Note: ● Standard Outfit, ○ Optional

Sample Image

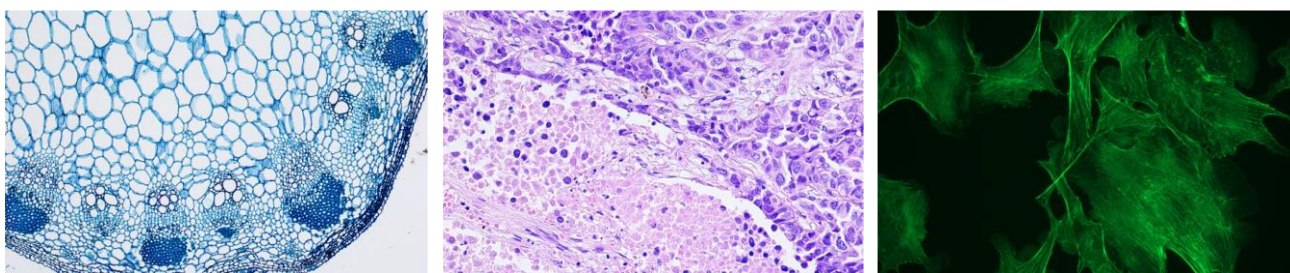

Dimension

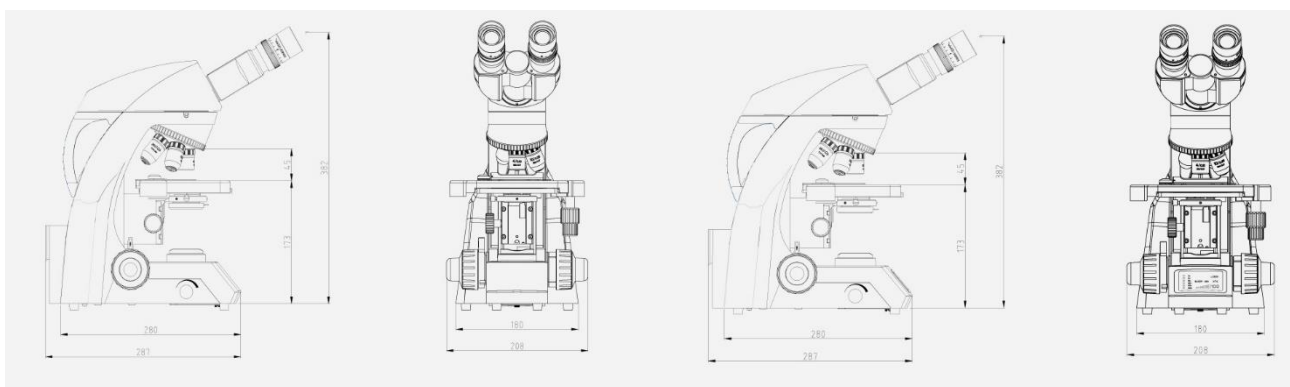

BS-2053B

BS-2054B

Unit: mm