

BS-2083 Research Biological Microscope



BS-2083



BS-2083F

Introduction

BS-2083 biological microscope has been designed to present a safe, comfortable and precision observation experience. The motorized nosepiece and condenser will make your works easier. With perfectly performed structure, high-definition optical image and ergonomical operating system, BS-2083 realizes professional analysis and meets all the needs of research in biological, medical, life science and other fields.

Features

1. Sapphire Glass Stage Insert.



Mechanical stage with sapphire glass insert is durable, never could be scratched and allows users to clear the stage easily.

2. Put Slide by One Hand.



It is easy for users to put slides by one hand due to the special designed slide clip.

3. Image Capture Button.



There is a cable from the microscope, the cable could be connected to the digital camera, after connection, just press the "CAPTURE" button at the right side of the microscope base, then you could capture the image easily.

4. Tilting Trinocular Head.



- (1) The eye tube can be adjusted from 0°-35°.
- (2) Digital cameras or DSLR cameras can be connected to the trinocular tube.
- (3) The beam splitter has 3-position (100:0, 20:80, 0:100).
- (4) The splitter bar can be assembled on the either side according to user's requirements.

5. Low-Position Focusing System.

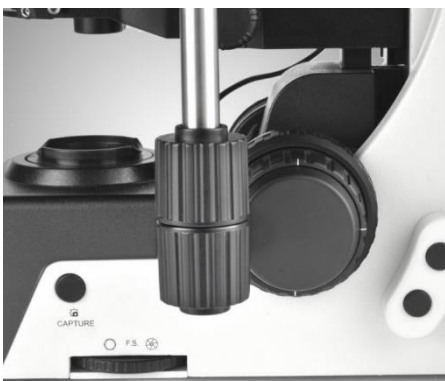

Very precise coaxial focusing system with fine division of 1 μ m, it comes with low-position coarse and fine focusing knobs, the ergonomic design provides comfortable experience for users.

6. Motorized Objective Change.



Objectives could be switched by simply pressing the buttons. Users could also self-define two of the most commonly used objectives and switch between them with the green button.

The illumination has connection with the objective, when the objective is changed, the light intensity will also be changed accordingly.

7. Nosepiece Rotating Buttons.



This microscope has the function of motorized rotating nosepiece with the 2 buttons.

8. Motorized Swing-out Condenser.



The top-lens on the condenser will be automatically swing-in or swing-out according to the objective lens that is selected.

9. Light Intensity Management.

The illumination has connection with the objective, when the objective is changed, the light intensity will also be changed accordingly. Thus, from low to high magnification, the field of view maintains the same brightness. There is no need to manually adjust the intensity of the light and also reduce eye fatigue. The long-life LED light source ensures uniform brightness while is easy to maintain.



Application

This microscope is an ideal instrument in biological, histological, pathological, bacteriology, immunizations and pharmacy field and can be widely used in medical and sanitary establishments, laboratories, institutes, academic laboratories, colleges and universities.

Specification

Item	Specification	BS-2083	BS-2083F	
Optical System	NIS60 Infinite Color Corrected Optical System	●	●	
Viewing Head	Ergo Tilting Trinocular Head, adjustable 0-35° inclined, interpupillary distance 47mm-78mm; splitting ratio Eyepiece:Trinocular=100:0 or 20:80 or 0:100	●	●	
	Seidentopf Trinocular Head, 30° inclined, interpupillary distance: 47mm-78mm; splitting ratio Eyepiece:Trinocular=100:0 or 20:80 or 0:100	○	○	
	Seidentopf Binocular Head, 30° inclined, interpupillary distance: 47mm-78mm	○	○	
Eyepiece	Super wide field plan eyepiece SW10X/25mm, diopter adjustable	●	●	
	Super wide field plan eyepiece SW10X/22mm, diopter adjustable	○	○	
	Extra wide field plan eyepiece EW12.5X/16mm, diopter adjustable	○	○	
	Wide field plan eyepiece WF15X/16mm, diopter adjustable	○	○	
	Wide field plan eyepiece WF20X/12mm, diopter adjustable	○	○	
Objective	N-PLN Plan Objective	N-PLN 2X/NA=0.06, WD=7.5mm	○	○
		N-PLN 4X/NA=0.10, WD=30mm	●	●
		N-PLN 10X/NA=0.25, WD=10.2mm	●	●
		N-PLN 20X/NA=0.40, WD=12mm	●	●
		N-PLN 40X/NA=0.65, WD=0.7mm	●	●
		N-PLN 100X(Oil)/NA=1.25, WD=0.2mm	●	●
		N-PLN 50X(Oil)/NA=0.95, WD=0.19mm	○	○
		N-PLN 60X/NA=0.80, WD=0.3mm	○	○
	N-PLN PH Plan Phase Contrast Objective	N-PLN PH 10X/NA=0.25, WD=10.2mm	○	○
		N-PLN PH 20X/NA=0.40, WD=12mm	○	○
		N-PLN PH 40X/NA=0.65, WD=0.7mm	○	○
		N-PLN PH 100X(Oil)/NA=1.25, WD=0.2mm	○	○
	N-PLFN Plan Semi-apochromatic Fluorescent Objective	N-PLFN 4X/NA=0.13, WD=17.2mm	○	○
		N-PLFN 10X/NA=0.30, WD=16.0mm	○	○
		N-PLFN 20X/NA=0.50, WD=2.1mm	○	○
		N-PLFN 40X/NA=0.75, WD=1.5mm	○	○
	N-PLFN PH Plan Semi-apochromatic Fluorescent Phase Contrast Objective	N-PLFN PH 10X/NA=0.30, WD=15.8mm	○	○
		N-PLFN PH 20X/NA=0.50, WD=2.7mm	○	○
		N-PLFN PH 40X/NA=0.75, WD=1.35mm	○	○
		N-PLFN PH 100X(Oil)/NA=1.40, WD=0.18mm	○	○
N-PLFN PH 10X/NA=0.30, WD=15.8mm		○	○	

	N-PLPN Plan Apochromatic Objective	N-PLPN 10X/NA=0.45, WD=4.0mm	○	○
		N-PLPN 20X/NA=0.75, WD=1.1mm	○	○
		N-PLPN 40X/NA=0.95, WD=0.21mm	○	○
		N-PLPN 60X(Oil)/NA=1.42, WD=0.25mm	○	○
		N-PLPN 100X(Oil)/NA=1.45, WD=0.13mm	○	○
Nosepiece	Motorized Backward Sextuple Nosepiece (with DIC slot)	●	●	
Condenser	Swing-out type condenser N.A.0.9/0.25(Auto)	●	●	
	Turret Phase Contrast Condenser	○	○	
	Dark-field Condenser (Dry), used for objectives lower than 100X	○	○	
	Dark-field Condenser (Oil), used for 100X objective	○	○	
Transmitted Illumination	3W S-LED lamp, center pre-set, intensity adjustable	●	●	
	12V/100W halogen lamp, center pre-set, intensity adjustable	○	○	
Focusing	Low-position coaxial coarse and fine focusing, fine division 1μm, Moving range 35mm	●	●	
Stage	Double layers mechanical stage, size 190mmX152mm; moving range 78mmX54mm (double slides holder, Right or left handle); precision: 0.1mm; with Sapphire Crystal Glass Insert	●	●	
	Double layers mechanical stage, size 190mmX152mm; moving range 78mmX54mm (double slides holder, Right or left handle); precision: 0.1mm	○	○	
DIC Kit	10X DIC Objective Lens	○	○	
	20X DIC Objective Lens	○	○	
	Polarizer for DIC Kit	○	○	
	DIC insert plate(10X/20X), can be inserted into the DIC slot on nosepiece	○	○	
	DIC insert plate(40X/100X) can be inserted into the DIC slot on nosepiece	○	○	
	DIC Turret Condenser	○	○	
Reflected Fluorescence Illuminator (with mercury lamp)	Turret with 6 filter block cubes position, with iris field diaphragm and aperture diaphragm, central adjustable; with filter slot; with fluorescence B, G filters	○	●	
	100W mercury lamp house, filament center and focus adjustable; with reflected mirror, mirror center and focus adjustable.	○	●	
	Digital power controller, wide voltage 100-240VAC	○	●	
	ND6/ND25 Filter	○	○	
	U, V, R, FITC, DAPI, TRITC, Auramine, mCherry, FL-BG fluorescent filters	○	○	
Reflected Fluorescent Attachment (with LED lamps)	LED Reflected Fluorescent Attachment, Turret with 6-position for filter block cubes, including B, G fluorescent filters and B, G, U, R LED lamps (the LED lamps can be used for B, G, U, R, FITC, DAPI, TRITC fluorescent filters), there are 4 positions for the LED lamps	○	○	
	U, R, FITC, DAPI, TRITC fluorescent filters	○	○	
Other Accessories	0.5X, 1X C-mount Adapter	○	○	
	Dust Cover	●	●	
	Power Cord	●	●	
	Cedar Oil 5ml	●	●	
	Simple Polarizing kit	○	○	
	Calibration slide 0.01mm	○	○	

Multi Viewing Attachment for 2/3/5/7/10 person	○	○
--	---	---

Note: ● Standard Outfit, ○ Optional

Sample Image

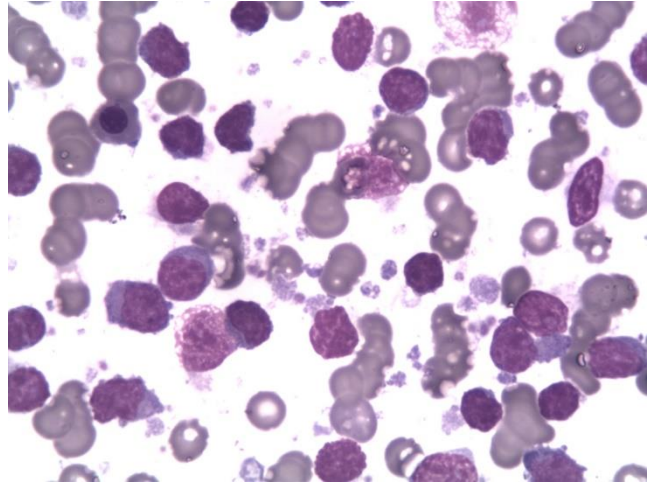
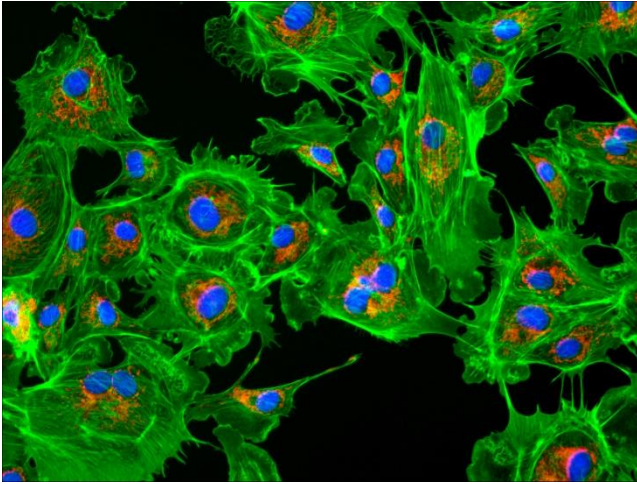

Accessories

1. N-PLN Series Plan Objectives.



The Plan objectives can provide flat high transmittance image from visible light to NIR light. They are usually used for bright-field viewing as the high signal-to-noise, high resolution and high contrast features.

2. N-PLN PH Series Plan Phase Contrast Objectives.



These plan phase contrast objectives are specially designed for phase contrast observation. They are good choice for clinic and scientific research. These objectives can provide advanced flat image of 25mm FOV under transmitted bright field.

3. N-PLFN Series Plan Semi-APO Fluorescent Objectives.



Owe to the multilayers coating technology, these Semi-APO objectives can compensate the spherical aberration and the chromatic aberration from ultraviolet and infrared light. High-sensitive fluorescence performance of the objectives ensures the sharpness, definition and color rendition of images.

4. Bright field Viewing.

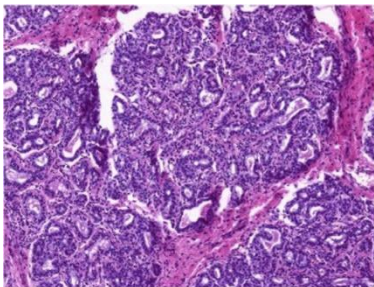

Mammary Gland (active stage)

Brighter image, high resolution and flatness, suitable for all the magnifications.

5. Fluorescent Viewing.

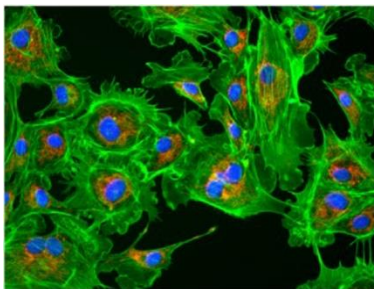

Arterial Cell

The compact epi-fluorescent components include noise elimination feature which ensures images captured are bright, with high contrast and high signal-to-noise ratio.

6. Phase Contrast Viewing.

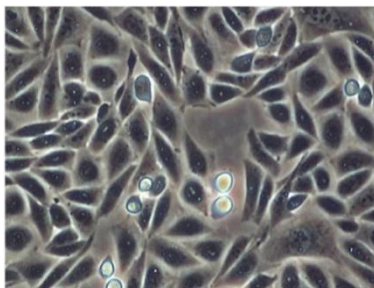

Rat Ovarian Cell

Users can get high contrast image of neutral background color whatever the magnification is. It is suitable for viewing non-stained specimen.

7. Polarizing Viewing.

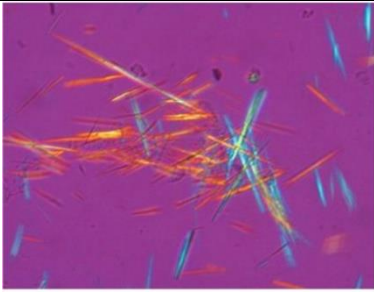

It is quite suitable for viewing collagen, amyloid and crystal etc., double refracting specimens.

Uric Acid Crystal

8. Dark-field Viewing.

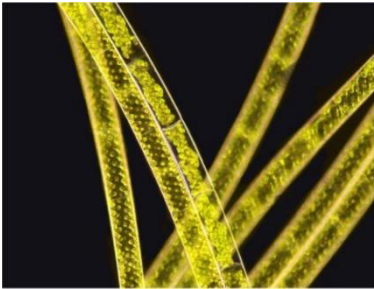

It can be used for clearly viewing of blood or flagellum etc., fine structure.

Spirogyra

9. Multi Viewing Heads.



2 Viewing heads (Face to Face)



2 Viewing heads (Side to Side)



5 Viewing heads

Dimension

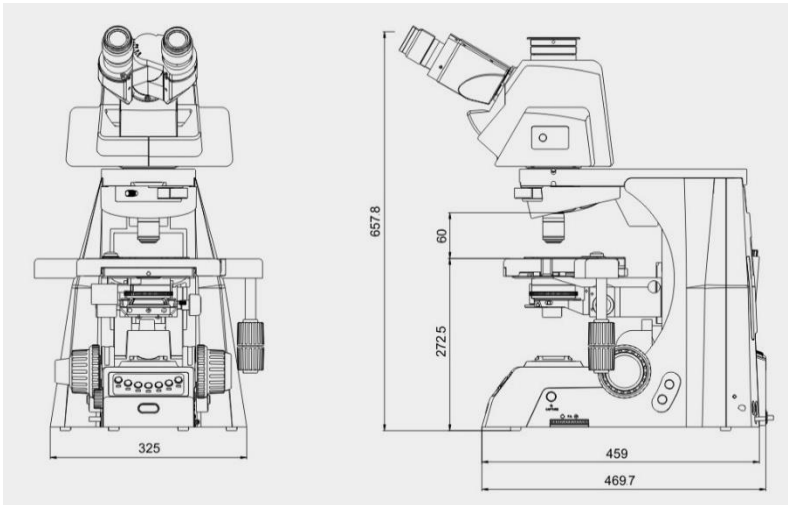

Unit: mm